

Hisense

life reimagined

Freezer

USER'S OPERATION MANUAL

Before operating this unit, please read this manual thoroughly, and retain for future reference

FV206D4AW1

English

Contents

Safety and warning information _____	2	Reversing the door _____	11
Installing your new appliance _____	8	Helpful hints and tips _____	13
Description of the appliance _____	9	Cleaning and care _____	14
Using your appliance _____	9	Troubleshooting _____	15
Control panel _____	10	Disposal of the appliance _____	16



Safety and warning information

For your safety and correct usage, before installing and first using the appliance, read this user manual carefully, including its hints and warnings. To avoid unnecessary mistakes and accidents, it is important to make sure that all people using the appliance are thoroughly familiar with its operation and safety features. Save these instructions and be sure that they remain with the appliance if it is moved or sold, so that anyone using it throughout its life, will be properly informed on its usage and safety notices.

For the safety of life and property, keep the precautions of these user's instructions as the manufacturer is not responsible for damages caused by omission.

Safety for children and others who are vulnerable people

- According to EN standard

This appliance can be used by children aged from 8 years and above and persons with reduced physical, sensory or mental capabilities or lack of experience and knowledge if they have been given supervision or instruction concerning use of the appliance in a safe way and understand the hazards involved. Children shall not play with the appliance. Cleaning and user maintenance shall not be made by children without supervision.

Children aged from 3 to 8 years are allowed to load and unload refrigerating appliances.

- According to IEC standard

This appliance is not intended for use by persons (including children) with reduced physical, sensory or mental capabilities, or lack of experience and knowledge, unless they have been given supervision or instruction concerning

use of the appliance by a person responsible for their safety. **Children should be supervised to ensure that they do not play with the appliance.**

- Keep all packaging away from children as there is risk of suffocation.
- If you are discarding the appliance, pull the plug out of the socket, cut the connection cable (as close to the appliance as you can) and remove the door to prevent children playing from suffering an electric shock or from closing themselves inside it.
- If this appliance, featuring a magnetic door seals, is to replace an older appliance having a spring lock (latch) on the door or lid, be sure to make the spring lock unusable before you discard the old appliance. This will prevent it from becoming a death trap for a child.

General safety



- **WARNING** — This appliance is intended to be used in household and similar applications such as
 - staff kitchen areas in shops, offices and other working environments;
 - farm houses and by clients in hotels, motels and other residential type environments;
 - bed and breakfast type environments;
 - catering and similar non-retail applications.
- **WARNING** — Do not store explosive substances such as aerosol cans with a flammable propellant in this appliance.
- **WARNING** — If the supply cord is damaged, it must be replaced by the manufacturer, its service agent or similarly qualified persons in order to avoid a hazard.
- **WARNING** — Keep ventilation openings, in the appliance enclosure or in the built-in structure, clear of obstruction.
- **WARNING** — Do not use mechanical devices or other means to accelerate the defrosting process, other than those recommended by the manufacturer.
- **WARNING** — Do not damage the refrigerant circuit.
- **WARNING** — Do not use electrical appliances inside the food storage compartments of the appliance, unless they are of the type recommended by the manufacturer.

-
- **WARNING** — The refrigerant and insulation blowing gas are flammable. When disposing of the appliance, do so only at an authorized waste disposal centre. Do not expose to flame.
 - **WARNING** —When positioning the appliance, ensure the supply cord is not trapped or damaged.
 - **WARNING** —Do not locate multiple portable socket-outlets or portable power supplies at the rear of the appliance.
 - **WARNING**—Food needs to be packed in bags before putting into the refrigerator, and liquids need to be packed in bottles or capped containers to avoid the problem that the product design structure is not easy to clean.



The symbol  is a warning and indicates the refrigerant and insulation blowing gas are flammable.

Warning: Risk of fire / flammable materials

Replacing the illuminating lamps

- **WARNING**—The illuminating lamps must not be replaced by the user! If the illuminating lamps is damaged, contact the customer helpline for assistance.

This warning is only for refrigerators that contain illuminating lamps.

Refrigerant

The refrigerant isobutene (R600a) is contained within the refrigerant circuit of the appliance, a natural gas with a high level of environmental compatibility, which is nevertheless flammable. During transportation and installation of the appliance, ensure that none of the components of the refrigerant circuit becomes damaged.

The refrigerant (R600a) is flammable.

- **WARNING** — Refrigerators contain refrigerant and gases in the insulation. Refrigerant and gases must be disposed of professionally as they may cause eye injuries or ignition. Ensure that tubing of the refrigerant circuit is not damaged prior to proper disposal.

If the refrigerant circuit should be damaged:

- Avoid opening flames and sources of ignition.
- Thoroughly ventilate the room in which the appliance is situated

It is dangerous to alter the specifications or modify this product in any way.

Any damage to the cord may cause a shortcircuit, fire, and/or electric shock.



Electrical safety

1. The power cord must not be lengthened.
2. Make sure that the power plug is not crushed or damaged. A crushed or damaged power plug may overheat and cause a fire.
3. Make sure that you can access the main plug of the appliance.
4. Do not pull the main cable.
5. If the power plug socket is loose, do not insert the power plug. There is a risk of electric shock or fire.
6. You must not operate the appliance without the interior lighting lamp cover.
7. The fridge is only applied with power supply of single phase alternating current of 220~240V/50Hz. If fluctuation of voltage in the district of user is so large that the voltage exceeds the above scope, for safety sake, be sure to apply A.C. Automatic voltage regulator of more than 350W to the fridge. The fridge must employ a special power socket instead of common one with other electric appliances. Its plug must match the socket with ground wire.

Daily use

- Do not store flammable gass or liquids in the appliance, There is a risk of an explosion.
- Do not operate any electrical appliances in the appliance (e.g. electric ice cream makers, mixers etc.).
- When unplugging always pull the plug from the mains socket, do not pull on the cable.
- Do not place hot items near the plastic components of this appliance.

-
- Do not place food products directly against the air outlet on the rear wall.
 - Store pre-packed frozen food in accordance with the frozen food manufacture's instructions.
 - The appliances manufactures storage recommendations should be strictly adhered to. Refer to relrelevant instructions for storage.
 - Do not place carbonated or fizzy drinks in the freeze compartment as it creates pressure on the container, which may cause it to explode, resulting in damage to the appliance.
 - Frozen food can cause frost burns if consumed straight from the freezer compartment.
 - Do not place the appliance in direct sunlight.
 - Keep burning candles, lamps and other items with naked flames away from the appliance so that do not set the appliance on fire.
 - The appliance is intended for keeping food stuff and/or beverages in normal household as explained in this instruction booklet The appliance is heavy. Care should be taken when moving it.
 - Do not remove nor touch items from the freezer compartment if your hands are damp/wet, as this could cause skin abrasions or frost/freezer burns.
 - Never use the base, drawers, doors etc. to stand on or as supports.
 - Frozen food must not be refrozen once it has been thawed out.
 - Do not consume ice popsicles or ice cubes straight from the freezer as this can cause freezer burn to the mouth and lips.
 - To avoid items falling and causing injury or damage to the appliance, do not overload the door racks or put too much food in the crisper drawers.

caution!

Care and cleaning

- Before maintenance, switch off the appliance and disconnect the mains plug from the mains socket.
- Do not clean the appliance with metal objects, steam cleaner, ethereal oils, organic solvents or abrasive cleansers.
- Do not use sharp objects to remove frost from the appliance. Use a plastic scraper.

Installation Important!

- For electrical connection carefully, follow the instructions given in this manual.
Unpack the appliance and check if there are damages on it.
- Do not connect the appliance if it is damaged. Report possible damages immediately to the place you bought it. In this case retain packing.
- It is advisable to wait at least four hours before connecting the appliance to allow the oil to flow back in the compressor.
- Adequate air circulation should be around the appliance, lacking this leads to overheating. To achieve sufficient ventilation, follow the instructions relevant to installation.
- Wherever possible the back of the product should not be too close to a wall to avoid touching or catching warm parts (compressor, condenser) to prevent the risk of a fire, follow the instructions relevant to installation.
- The appliance must not be locate close to radiators or cookers.
- Make sure that the mains plug is accessible after the installation of the appliance.

Service

- Any electrical work required to do the servicing of the appliance should be carried out by qualified electrician or competent person.
- This product must be serviced by an authorized Service Center, and only genuine spare parts must be used.
 - 1)If the appliance is Frost Free.
 - 2)If the appliance contains freezer compartment.

Installing your new appliance

Before using the appliance for the first time, you should review the following tips.

Ventilation of appliance

 In order to improve efficiency of the cooling system and save energy, it is necessary to maintain good ventilation around the appliance. For this reason, sufficient clear space should be available around the refrigerator. It is advisable for there to be 50-70mm of space from the back to the wall, at least 100mm from its top, at least 100mm from its side to the wall and a clear space in front to allow the doors to open 135°. Please see the following diagrams.

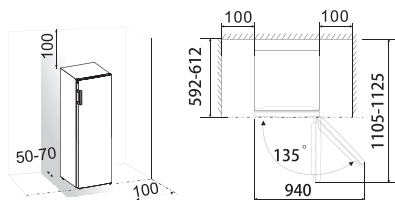

●Note:

This appliance performs well within the climate class from N to ST showed in the table below.

It may not work properly if left at a temperature above or below the indicated range for a long period.

Climate class	Ambient temperature
SN	+10°C to +32°C
N	+16°C to +32°C
ST	+16°C to +38°C
T	+16°C to +43°C

- Stand your appliance in a dry place to avoid moisture damage.
- Keep the appliance out of direct sunlight, rain or frost. Stand the appliance away from heat sources such as stoves, fires or heaters.

Leveling of appliance

- For sufficient leveling and air circulating in the lower rear section of the appliance, the bottom feet may need to be adjusted.
- You can adjust them manually using a suitable spanner. To allow the doors to self-close, tilt the top backwards by about 10mm.

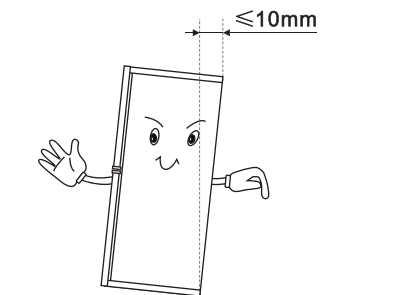

Description of the appliance

View of the appliance

- 1. Control panel
- 2. Serving tray
- 3. Middle drawer
- 4. Lower drawer
- 5. Adjustable bottom feet
- 6. Handle
- 7. Freezer door

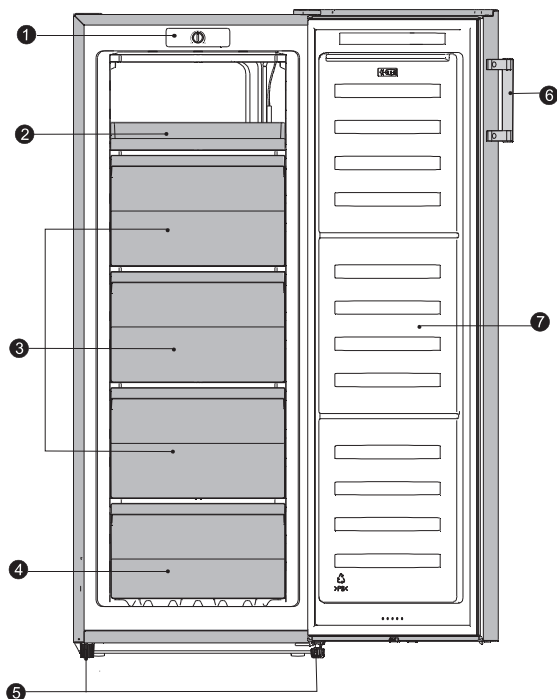

Note: Due to constant development of our products, your refrigerator may be slightly different from this instruction manual, but its functions and usage remain the same.

Using your appliance

Accessories ¹⁾

Freezer Drawer

- For storing frozen food.

Ice-cube tray

- For making ice and storing ice-cubes.

Freezer food compartment ²⁾

- For freezing fresh food and storing frozen and deep-frozen food for long periods of time.

Thawing food ²⁾

- In the freezer compartment.
- At room temperature.
- In a microwave oven.
- In a conventional or convection oven.
- Food once thawed should be re-frozen with the exception of special cases.

1) If the appliance contains related accessories and functions.

2) If the appliance contains a freezer compartment.

Control panel

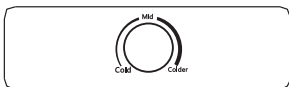

The thermostat control situated in the control panel regulates the temperature of the freezer compartment.

- Position "Cold"—Cold.
- Position "Mid"—Colder normally, setting at this position.
- Position "Colder"—Coldest.

The temperature will be affected by:

- Room temperature
- How often the door is opened
- How much food is stored
- Position of the appliance

In determining the correct temperature control setting, all these factors have to be considered and some experimentation may be necessary. Do not allow children to tamper with the controls or play with the product.

Important!—Normally we advise you select setting of "Mid", if you want the temperature higher or lower please turn the knob to Warmer or colder setting accordingly.

When you turn the knob to colder which can lead to the more energy efficiency. Otherwise, it would result the energy-consuming.

Important!—High ambient temperatures (e.g. on hot summer days) and a cold setting on the temperature regulator (position "Colder") can cause the compressor to run continuously or even non-stop!

Reason: when the ambient temperature is high, the compressor must run continuously to maintain the low temperature in the appliance.

The freezer compartment

The ❄️ symbol means that your freezer will store frozen food at $-18^{\circ}\text{C}(-0.4\text{F})$ or colder allowing for long term frozen-food storage and freezing of fresh food. The freezer temperature is controlled automatically by the thermostat situated in the control panel. Due to the different installations, methods of usage and weather conditions, adjustments to the temperature settings may be required.

These are best assessed against a temperature reading on a thermometer buried in the frozen food. The reading must be taken quickly as the thermometer

temperature will rise rapidly after removal.

Place the fresh food in the top freezer drawer. Food may need rearranging to achieve this. During the freezing process the temperature of fresh food should be reduced quickly so that ice crystals are kept as small as possible to avoid damaging the structure of food. If freezing takes place slowly large ice crystals form and these will affect the quality of food once it has defrosted. Existing frozen food should be rearranged to leave space in the top two drawers for freezing. The packets to be frozen should be placed in the drawer in contact with the drawer surface as far as possible and spaced apart to allow cold air to circulate between them. They should not touch existing packets. If there is enough room, transfer the food you have frozen to the baskets or drawers to allow you to freeze a further load in the top drawer. Exceptionally large items can be stored by removing the drawer. Frozen food should not be refrozen once it has thawed out. Do not remove items from the freezer if your hands are damp/wet, as this could cause skin abrasions or "frost/freezer burns". For safety reasons, the freezer drawer are fitted with stops but are readily removed by pulling them forward to the stop, then lifting the front and pulling all the way out. Refit by reversing this procedure.

Frozen food storage







Pre-packed commercially frozen food should be stored in accordance with the manufacturer's instructions for a 4 star frozen food compartment and should be put in the freezer as soon as possible after purchase. Your freezer provides for long term storage which generally means up to 3 months but the length of the time can vary and it is important to follow the recommended times shown on packets of commercially frozen food. Do not place sealed containers or carbonated liquids such as fizzy drinks into the freezer as it creates pressure on the container which may cause it to explode leading to damage to the freezer. Ice cubes and ice lollies should not be consumed immediately after removal from the freezer as it may result in low temperature skin abrasions.

Reversing the door

The side at which the door opens can be changed, from the right side (as supplied) to the left side, if required.

Warning! When reversing the door, the appliance must not be connected to the mains. Ensure that the plug is removed from the mains socket.

Tools you will need

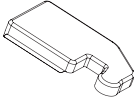
Not provided		
		
8mm socket wrench	Thin-blade screwdriver	Putty knife
		
Cross-shaped screwdriver	Monkey wrench	8mm wrench
Additional parts (in the plastic bag)		
		
Left Hinge Cover		

Note: If required you may lay the refrigerator on its back in order to gain access to the base, you should rest it on soft foam packaging or similar material to avoid damaging the backboard of the refrigerator. To reverse the door, the following steps are generally recommended.

1. Use a putty knife or thin-blade screwdriver to prize the screw hole cover which is at the top left corner of the refrigerator, and the upper hinge cover which is at the top right corner of the refrigerator.

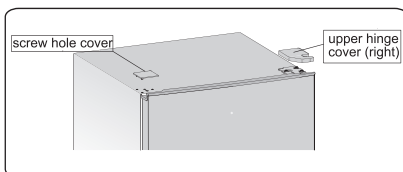

2. Unscrew the special flange self-tapping screws which are used for fixing the right upper hinge part by a 8mm socket driver or a spanner (please support the upper door with your hand when doing it).

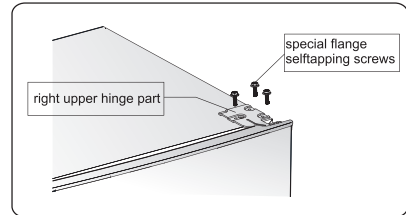

3. Remove the upper hinge axis, transfer it to reversed side and tighten securely, then put it in a safe place.

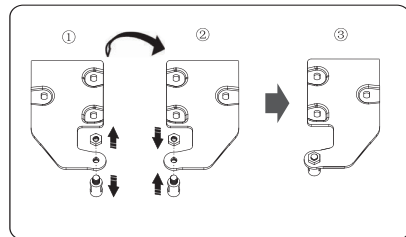

4. Remove the door from the lower hinge. **NOTE:** When removing the door, watch for washer(s) between the lower hinge and the bottom of the lower door that may stick to the door. Do not lose.

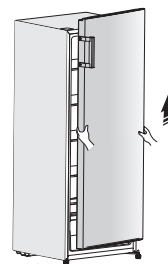

5. Place it on a smooth surface with its panel upwards. Loose screw ② and part ①, then install them to the left side and tighten securely.

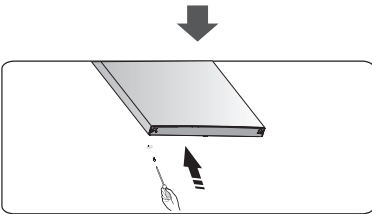
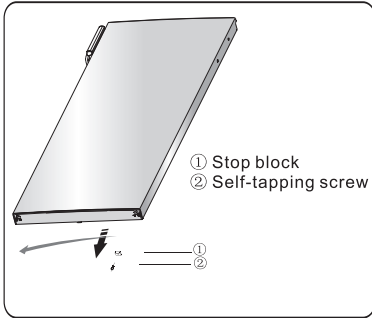

6. Lay the refrigerator on soft foam packaging or similar material. Remove both adjustable bottom feet parts, and the lower hinge part by unscrewing the special flange self-tapping screws.

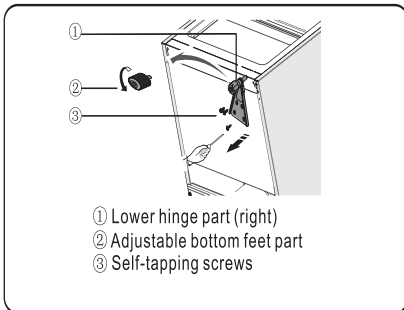

7. Replace the lower hinge part to the left side and fixing it with the special flange self-tapping screws. Replace the adjustable bottom feet parts to another side and fixing it.

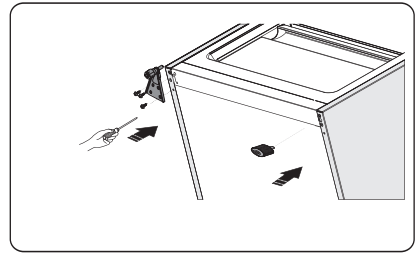

8. Transfer the door to the property position, adjust the lower hinge part, make the hinge axis into the lower hole of the door.

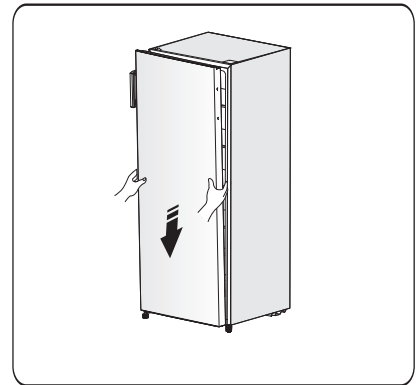

9. Transfer the upper hinge part and make the upper hinge axis into the upper hole of the door, and adjust the position of the door (please support the door with your hand when doing it), fixing the upper hinge part with the special flange self-tapping screws.

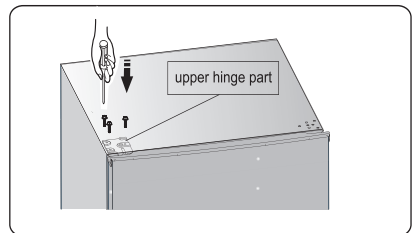

10. Install the screw hole cover on the top right corner of the refrigerator. Install the upper hinge cover (which is in the plastic bag) on the left corner. Put the other upper hinge cover into the plastic bag.

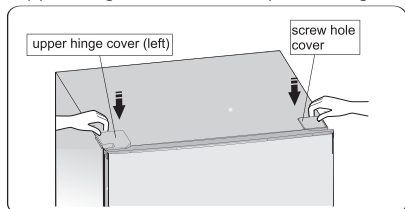

11. Move the handle from the left side of door to the right side .

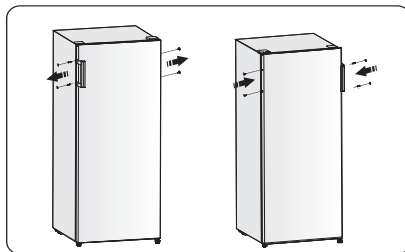

12. Open the upper door and install the door shelves, then close it.

Warning!

When changing the side at which the door opens, the appliance must not be connected to the mains. Remove plug from the mains beforehand.

Helpful hints and tips

Noises during operation

Clicks- Whenever the compressor switches on or off, a click can be heard.

Humming- As soon as the compressor is in operation, you can hear it humming.

Bubbling- When refrigerant flows into thin tubes, you can hear bubbling or splashing noises.

Splashing- Even after the compressor has been switched off, this noise can be heard for a short time.

Energy saving tips

- Do not install the appliance near stoves, radiators or other sources of warmth.
- Keep the time the appliance is open to a minimum.
- Do not set the temperature colder than necessary.
- Make sure the side plates and back plate of the appliance are at some distance from the wall, and follow the instructions relevant to installation.
- If the diagram shows the correct combination for the drawers, crisper and shelves, do not adjust the combination as it would produce an effect on energy consumption.

Hints for freezing

- When first starting-up or after a period out of use. Before putting the food in the compartment, let the appliance run at least 2 hours on the higher settings.

- Prepare food in small portions to enable it to be rapidly and completely frozen and to make it possible to subsequently thaw only the quantity required.
- Wrap up the food in aluminum foil or polyethylene (plastic) and make sure that the packages are airtight.
- Do not allow fresh, unfrozen food to touch food that is already frozen, thus avoiding a rise in the temperature of the latter.
- Iced products, if consumed immediately after removal from the freezer compartment, can possibly cause skin to become freezer burnt.
- It is recommended to label and date each frozen package in order to keep track of the storage time.

Hints for the storage of frozen food

- Make sure that commercially frozen food was stored by the retailer.
- Once defrosted, foods deteriorate rapidly and can not be re-frozen.
- Do not exceed the storage period indicated by the food manufacturer.

Note: If the appliance contains related accessories and functions.

Cleaning and care

Cleaning and care

For hygienic reasons, the appliance interior, including interior accessories, should be cleaned regularly.

The appliance should be cleaned and maintained at least every two months.



Warning! Danger of electrical shock!

- The appliance should not be connected to the main power supply during cleaning. Before cleaning, switch the appliance off and remove the plug from the main power supply, switch off, or shut off the circuit breaker or fuse.

Notice!

- Remove the food from the appliance before cleaning. Store them in a cool place and keep well covered.
- Never clean the appliance with a steam cleaner. Moisture could accumulate in electrical components.
- Hot vapors can lead to the damage of plastic parts.
- Ethereal oils and organic solvents can attack plastic parts, e.g. lemon juice or the juice from an orange peel, butyric acid, or cleansers that contain acetic acid. Do not allow such substances to come into contact with appliance parts.
- Do not use any abrasive cleansers.
- Clean the appliance and the interior accessories with a cloth and lukewarm water. Commercially available dish washing detergents may also be used.
- After cleaning, wipe with fresh water and a clean dish cloth.
- Accumulation of dust at the condenser increases energy consumption; clean the condenser at the back of the appliance once a year with a soft brush or a vacuum cleaner. (Only for the outside-condenser product)
- Check the water drain hole on the rear wall of the refrigerator compartment.
- Clear a blocked drain hole with the aid of something like soft green peg, an be careful not to create any damage to the cabinet by sharp objects.
- After everything is dry, the appliance back into service.

Defrosting

Defrosting in the frozen food storage compartment

- Defrosting in the freezer chamber is operated manually. Before defrosting, take the food out.
- Take the ice tray and drawers out or put them into the fresh food compartment temporarily.
- Leave the door of the refrigerator open until ice and frost dissolve thoroughly and accumulate at the bottom of the freezer chamber. Wipe out the water with the soft cloth.
- In order to speed up the process of defrosting, you may put a bowl of warm water (about 50°C) into the freezer chamber and scrape away the ice and frost with a defrosting spatula. After doing so, be sure to set the knob of the temperature regulator to the original position.
- It is not advisable to heat the freezer chamber directly with hot water or a hair dryer while defrosting to avoid deformation of the inner case.
- It is also not advisable to scrape off ice and frost or separate foods from the containers which have been congealed together with the food with sharp tools or wooden bars, so as not to damage the inner casing or the surface of the evaporator.

Notice! The appliance should be defrosted at least once a month. During its usage, if the door has been opened frequently the appliance has been used in extreme humidity, we advise the user to defrost every two weeks.

Taking the appliance out of service

- Empty the appliance.
- Pull out the power plug.
- Clean thoroughly (see section: Cleaning and Care).
- Leave the door open to prevent odours.

Troubleshooting



Warning! Before trouble-shooting, disconnect the power supply. Only a qualified electrician or other personnel must carry out the trouble-shooting that is not in the manual.

Important!

Repairs to the appliance may only be performed by competent service engineers. Improper repairs can give rise to significant hazards for the user. If your appliance needs repairing, please contact your specialist dealer or your local Customer Service Center.

Problem	Possible cause	Solution
Appliance does not work.	Appliance is not switched on.	Switch on the appliance.
	Main plug is not plugged in or is loose.	Plug the appliance into the electrical socket.
	Fuse has blown or is defective.	Check fuse, replace if necessary.
	Outlet is defective.	Defective parts need to be repaired by an electrician.
Appliance cools too much.	Temperature is set too cold.	Turn the temperature regulator to a warmer setting temporarily.
The food is too warm.	Temperature is not properly adjusted.	Please refer to the "Initial Start Up" section.
	Door was open for an extended period.	Open the door only as long as necessary.
	A large quantity of warm food was placed in the appliance within the last 24 hours.	Turn the Control panel to a colder setting temporarily.
	The appliance is near a heat source.	Please refer to the "Installation Location" section.
Interior lighting does not work.	Light bulb is defective.	Please look in the "Changing the Light Bulb" section.
Heavy build-up of frost, possibly also on the door seal.	Door seal is not air-tight (possibly after reversing the door).	Carefully warm the leaking sections of the door seal with a hair dryer (on a cool setting). At the same time, shape the warmed door seal by hand so that it sits correctly.
Unusual noises.	Appliance is not level.	Readjust the feet.
	The appliance is touching the wall or other objects.	Move the appliance slightly.
	A component, e.g. a pipe, on the rear of the appliance is touching another part of the appliance or the wall.	If necessary, carefully bend the component out of the way.
The compressor does not start immediately after changing the temperature setting.	This is normal, no error has occurred.	The compressor starts after a period of time.
Water on the floor or storage shelves.	Water drain hole is blocked.	Refer to the "Cleaning and Care" section.

Disposal of the appliance

It is prohibited to dispose of this appliance as household waste.

Packaging materials

Packaging materials with the recycle symbol are recyclable. Dispose of the packaging into a suitable waste collection container to recycle it.

Before disposal of the appliance

1. Pull out the mains plug from the mains socket.
2. Cut off the power cord and discard with the mains plug

Warning! Refrigerators contain refrigerant and gases in the insulation. Refrigerant and gases must be disposed of professionally as they may cause eye injuries or ignition.

Ensure that tubing of the refrigerant circuit is not damaged prior to proper disposal.

	Correct Disposal of this product
	<p>This symbol on the product or in its packing indicates that this product may not be treated as household waste. Instead, it should be taken to the appropriate waste collection point for the recycling of electrical and electronic equipment. By ensuring this product is disposed of correctly, you will help prevent potential negative consequences for the environment and human health, which could otherwise be caused by the inappropriate waste handling of this product. For more detailed information about the recycling of this product, please contact your local council, your household waste disposal service, or the shop where you purchased the product.</p>

To avoid contamination of food, please respect the following instructions

- Opening the door for long periods can cause a significant increase of the temperature in the compartments of the appliance.
- Clean regularly surfaces that can come in contact with food and accessible drainage systems.
- Store raw meat and fish in suitable containers in the refrigerator, so that it is not in contact with or drip onto other food.
- Two-star frozen-food compartments are suitable for storing pre-frozen food, storing or making icecream and making ice cubes.
- One-, two- and three-star compartments are not suitable for the freezing of fresh food.

Order	Compartments TYPE	Target storage temp.[°C]	Appropriate food
1	(***)*-Freezer	≤ -18	Seafood (fish, shrimp, shellfish), freshwater aquatic products and meat products (recommended for 3 months, the longer the storage time, the worse the taste and nutrition), suitable for frozen fresh food.
2	***-Freezer	≤ -18	Seafood (fish, shrimp, shellfish), freshwater aquatic products and meat products (recommended for 3 months, the longer the storage time, the worse the taste and nutrition), are not suitable for frozen fresh food.
3	** -Freezer	≤ -12	Seafood (fish, shrimp, shellfish), freshwater aquatic products and meat products (recommended for 2 months, the longer the storage time, the worse the taste and nutrition), are not suitable for frozen fresh food.
4	*-Freezer	≤ -6	Seafood (fish, shrimp, shellfish), freshwater aquatic products and meat products (recommended for 1 months, the longer the storage time, the worse the taste and nutrition), are not suitable for frozen fresh food.
5	0-star	-6 ~ 0	Fresh pork, beef, fish, chicken, some packaged processed foods, etc. (Recommended to eat within the same day, preferably no more than 3 days). Partially encapsulated processed foods (non-freezable foods)

Note: please store different foods according to the compartments or target storage temperature of your purchased products.

- If the refrigerating appliance is left empty for long periods, switch off, defrost, clean, dry, and leave the door open to prevent mould developing within the appliance.

Water dispenser cleaning (special for water dispenser products):

- Clean water tanks if they have not been used for 48 h; flush the water system connected to a water supply if water has not been drawn for 5 days.

Hisense

life reimagined